



ONCE UPON A TIME...WATER®

MOROKA™

BF2171

3-way AQUATONIK™ type T/P 1/2" valve with diverter and decorative trim

SPECIFICATIONS

Features

- Solid brass construction
- Operates 1 or 2 components at a time
- No visible screws
- Integrated service stops
- Two male water inlets 1/2NPT threaded or welded
- Two male water outlets 1/2NPT threaded or welded
- Total adjustment of 32 mm (1 1/4")
- Can be installed back-to-back
- Support for better stability during installation included

Colors (Finishes)

- Chrome: BF2171-110
- Matte Black: BF2171-160

Maximum flow rate

- 1 outlet: 22 L/min (5.9 gpm) at 60 psi
- 2 outlets: 23.5 L/min (6.21 gpm) at 60 psi

Certifications

The specified model meets or exceeds the following standards;



Installation Notes

This product must be installed following the installation instructions provided.

WARRANTY

Kalia Inc. guarantees all aspects of its products to be free of defects in material and workmanship for normal residential use. Refer to the warranty included with the Kalia products for details.

Product dimensions:

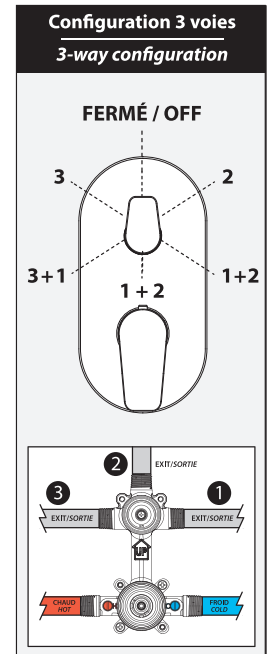
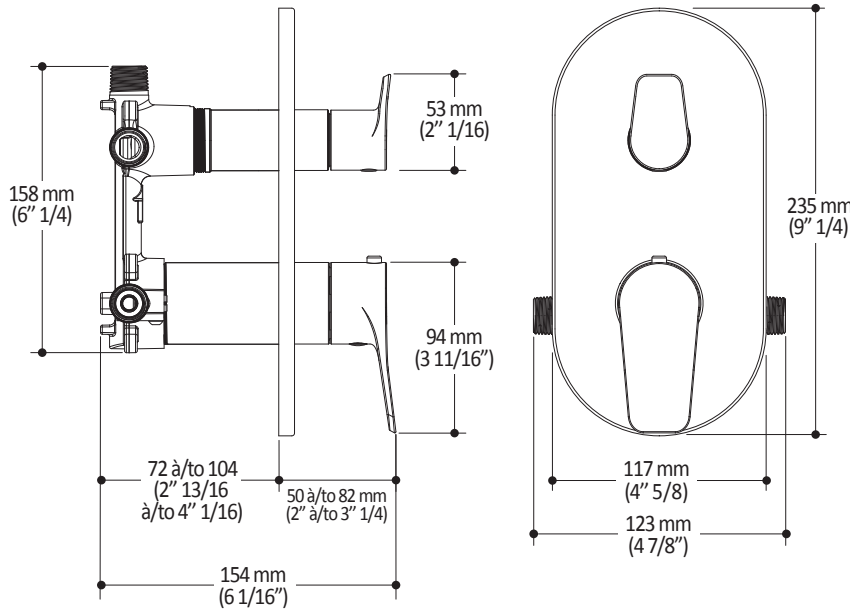

Important: Dimensions are approximated and are subject to changes. Please refer to the installation instructions.



ONCE UPON A TIME...WATER®

1355, 2nd Street, Industrial Park
Sainte-Marie (Québec)
Canada G6E 1G9

T 418-387-9090
1-877-GO-KALIA (1-87- 465-2542)
F 418 387-9089

KaliaStyle.com