

**BF2101-XXX-200****PREMIA: TB3 Thermostatic Shower System****SPECIFICATIONS****Components included**

- BF2062-XXX*: 3-way AQUATONIK™ type T/P 1/2" push-button valve and decorative trim (operates up to 3 components simultaneously)
 - BF2159-XXX*: Rainhead with 90° wall arm
 - 107381-XXX*: 3-jet handshower (mist spray, rain spray and mixed spray)
 - 107389-XXX*: Wallbar
 - 107393-XXX*: Wall outlet
 - 106415-XXX* : Tub spout
 - 101620-XXX*: 60" flexible and soft PVC hose
- *XXX means that the finish color must be specified.*

Colors (Finishes)

- Chrome: BF2101-**110**-200
- Matte Black: BF2101-**160**-200
- Pure nickel PVD: BF2101-**125**-200

See the following sheets for the technical features of each component.

Installation Notes

This product must be installed following the installation instructions provided.

WARRANTY

Kalia Inc. guarantees all aspects of its products to be free of defects in material and workmanship for normal residential use. **Refer to the warranty included with the Kalia products for details.**





ONCE UPON A TIME...WATER®

BF2062

3-way AQUATONIK™ type T/P 1/2" push-button valve and decorative trim

SPECIFICATIONS

Features

- Solid brass construction
- Low-profile design
- Two male water inlets 1/2 NPT threaded or welded
- Male water outlets 1/2 NPT threaded or welded
- Horizontal or vertical installation
- One (1) high-flow outlet for tub spout
- Total adjustment of 25.4 mm (1")
- Back supports for better stability during installation included
- Operates up to 3 components simultaneously
- Integrated adjustable high-temperature limit
- Extra buttons included for custom shower configurations

Colors (Finishes)

- Chrome: BF2062-110
- Pure Nickel PVD: BF2062-125
- Matte Black: BF2062-160

Maximum flow rate

- 1 outlet: 31.9 L/min (7.42 gpm) at 60 psi
- 2 outlets: 32.3 L/min (8.53 gpm) at 60 psi
- 3 outlets: 33.5 L/min (8.85 gpm) at 60 psi

Certifications

The specified model meets or exceeds the following standards;

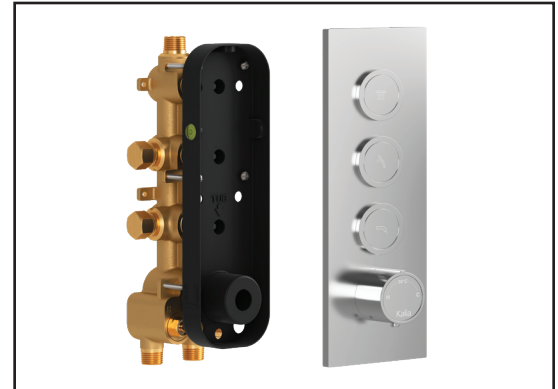

Installation Notes

This product must be installed following the installation instructions provided.

WARRANTY

Kalia Inc. guarantees all aspects of its products to be free of defects in material and workmanship for normal residential use. Refer to the warranty included with the Kalia products for details.

Product dimensions:

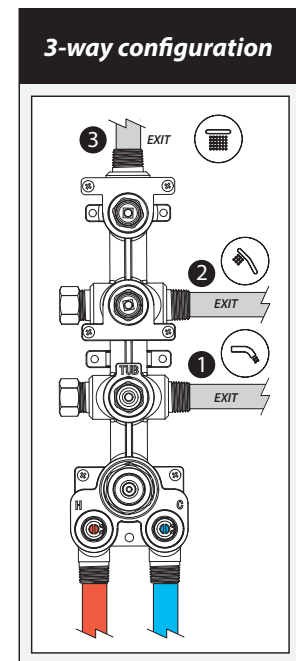

Important: Dimensions are approximated and are subject to changes. Please refer to the installation instructions.



ONCE UPON A TIME...WATER®

1355, 2nd Street, Industrial Park
Sainte-Marie (Québec)
Canada G6E 1G9

T 418-387-9090
1-877-GO-KALIA (1-877-465-2542)
F 418 387-9089

KaliaStyle.com



ONCE UPON A TIME...WATER®

BF2159 PREMIA: Rainhead with 90° Wallarm

SPECIFICATIONS

Features

- Solid brass arm and plastic rainhead construction
- Male water inlet 1/2NPT
- LSR (liquid silicone rubber) soft tips for easy cleaning of limescale
- Adjustable orientation swivel

Colors (Finishes)

- Chrome: BF2159-110
- Matte Black: BF2159-160
- Pure nickel PVD: BF2159-125

Maximum flow rate

- 7.6 L/min (2 gpm) to 80 psi

Certifications

The specified model meets or exceeds the following standards;



Installation Notes

This product must be installed following the installation instructions provided.

WARRANTY

Kalia Inc. guarantees all aspects of its products to be free of defects in material and workmanship for normal residential use. **Refer to the warranty included with the Kalia products for details.**

Product dimensions:

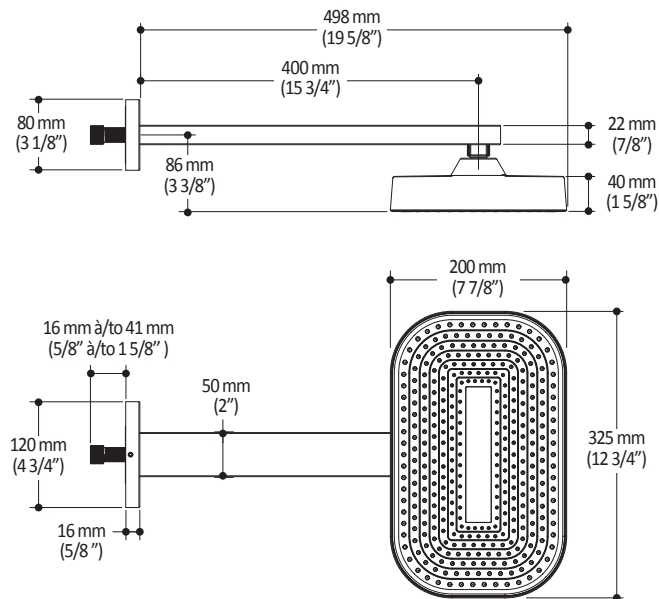

Important: Dimensions are approximated and are subject to changes. Please refer to the installation instructions.



ONCE UPON A TIME...WATER®

1355, 2nd Street, Industrial Park
Sainte-Marie (Québec)
Canada G6E 1G9

T 418-387-9090
1-877-GO-KALIA (1-87- 465-2542)
F 418 387-9089

KaliaStyle.com



ONCE UPON A TIME...WATER®

107381

PREMIA: 3-jet handshower

SPECIFICATIONS

Features

- Male water inlet G½
- 3-jet handshower: mist spray, rain spray and mixed spray
- LSR (liquid silicone rubber) soft tips for easy cleaning of limescale

Colors (Finishes)

- Chrome: 107381-110
- Matte Black: 107381-160
- Pure nickel PVD: 107381-125

Maximum flow rate

- 7.6 L/min (2 gpm) to 80 psi

Certifications

The specified model meets or exceeds the following standards;



Installation Notes

This product must be installed following the installation instructions provided.

WARRANTY

Kalia Inc. guarantees all aspects of its products to be free of defects in material and workmanship for normal residential use. Refer to the warranty included with the Kalia products for details.

Product dimensions:



Important: Dimensions are approximated and are subject to changes. Please refer to the installation instructions.



ONCE UPON A TIME...WATER®

1355, 2nd Street, Industrial Park
Sainte-Marie (Québec)
Canada G6E 1G9

T 418-387-9090
1-877-GO-KALIA (1-87- 465-2542)
F 418 387-9089

KaliaStyle.com



Kalia

ONCE UPON A TIME...WATER®

107389

PREMIA: Wallbar for handshower

SPECIFICATIONS

Features

- Solid brass construction
- Locking system
- Easy-to-use gliding system

Colors (Finishes)

- Chrome: 107389-110
- Matte Black: 107389-160
- Pure nickel PVD: 107389-125

Certifications

The specified model meets or exceeds the following standards:



CSA B125.1
ASME A112.18.1



Installation Notes

This product must be installed following the installation instructions provided.

WARRANTY

Kalia Inc. guarantees all aspects of its products to be free of defects in material and workmanship for normal residential use. **Refer to the warranty included with the Kalia products for details.**

Product dimensions:

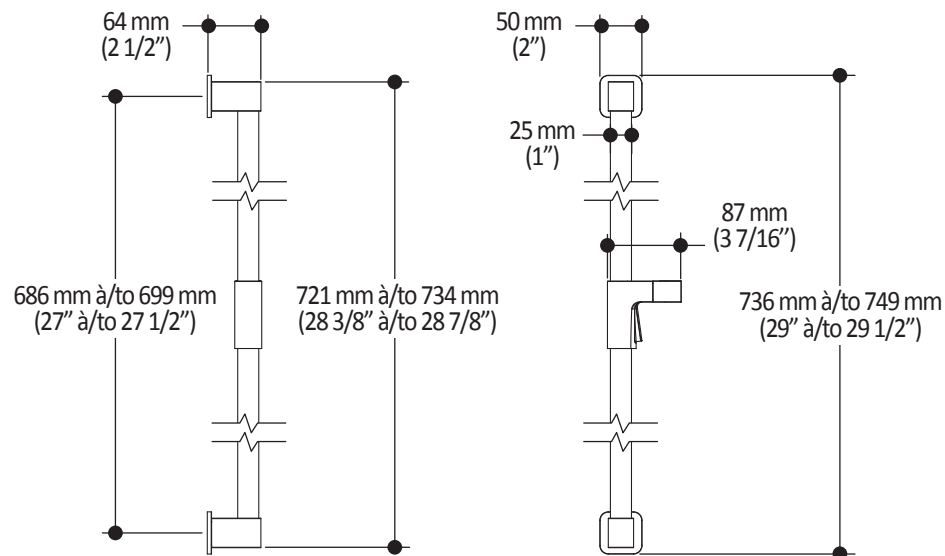

Important: Dimensions are approximated and are subject to changes. Please refer to the installation instructions.



Kalia

ONCE UPON A TIME...WATER®

1355, 2nd Street, Industrial Park
Sainte-Marie (Québec)
Canada G6E 1G9

T 418-387-9090
1-877-GO-KALIA (1-87- 465-2542)
F 418 387-9089

KaliaStyle.com



ONCE UPON A TIME...WATER®

107393 PREMIA: Wall outlet

SPECIFICATIONS

Features

- Solid brass construction
- Male water outlet G½
- Female water inlet 1/2NPT
- Connector adjustable in depth

Colors (Finishes)

- Chrome: 107393-110
- Pure Nickel PVD: 107393-125
- Matte Black: 107393-160

Certifications

The specified model meets or exceeds the following standards;



Installation Notes

This product must be installed following the installation instructions provided.

WARRANTY

Kalia Inc. guarantees all aspects of its products to be free of defects in material and workmanship for normal residential use. **Refer to the warranty included with the Kalia products for details.**

Product dimensions:



Important: Dimensions are approximated and are subject to changes. Please refer to the installation instructions.



ONCE UPON A TIME...WATER®

1355, 2nd Street, Industrial Park
Sainte-Marie (Québec)
Canada G6E 1G9

T 418-387-9090
1-877-GO-KALIA (1-87- 465-2542)
F 418 387-9089

KaliaStyle.com



Kalia

ONCE UPON A TIME...WATER®

KAREO™

106415 Tub Spout

SPECIFICATIONS

Features

- 1/2" cooper "slip fit" inlet or male water inlet 1/2NPT with 76 mm (3") adjustment
- Solid brass construction
- Regular water jet
- High water flow

Colors (Finishes)

- Chrome: 106415-110
- Matte Black: 106415-160
- Pure nickel PVD: 106415-125

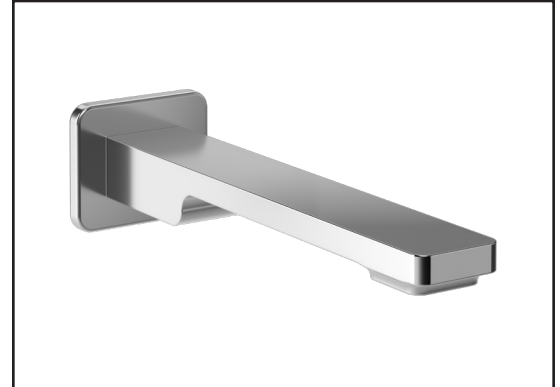

Installation Notes

This product must be installed following the installation instructions provided.

WARRANTY

Kalia Inc. guarantees all aspects of its products to be free of defects in material and workmanship for normal residential use. **Refer to the warranty included with the Kalia products for details.**

Product dimensions:

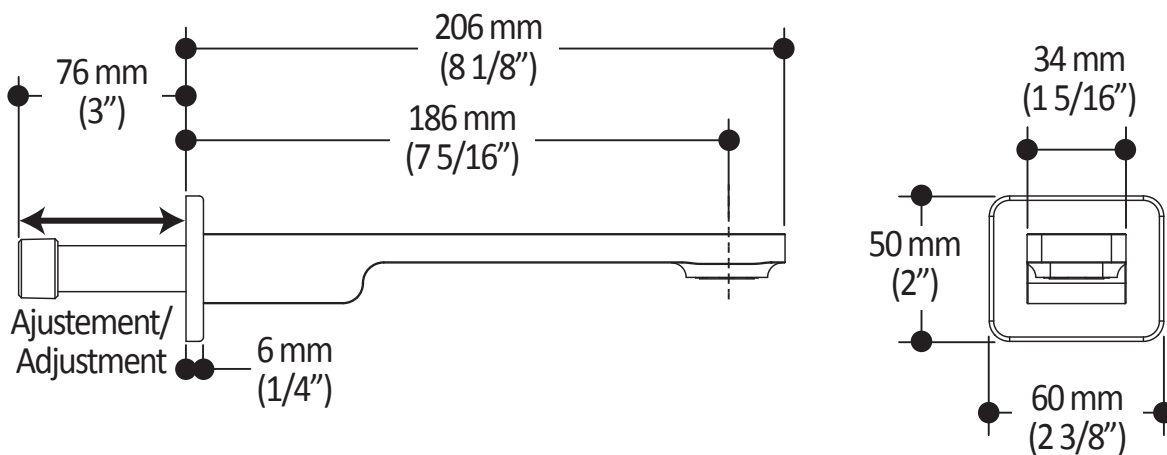

Important: Dimensions are approximated and are subject to changes. Please refer to the installation instructions.



Kalia

ONCE UPON A TIME...WATER®

1355, 2nd Street, Industrial Park
Sainte-Marie (Québec)
Canada G6E 1G9

T 418-387-9090
1-877-GO-KALIA (1-877-465-2542)
F 418 387-9089

KaliaStyle.com



Kalia

ONCE UPON A TIME...WATER®

101620

60" (1524 mm) Flexible and Soft PVC Hose

SPECIFICATIONS

Features

- G1/2 female connection
- Integrated check valve

Colors (Finishes)

- Chrome: 101620-110
- Pure Nickel PVD: 101620-125
- Black and chrome: 101620-150
- Matte Black: 101620-160



Installation Notes

This product must be installed following the installation instructions provided.

WARRANTY

Kalia Inc. guarantees all aspects of its products to be free of defects in material and workmanship for normal residential use. **Refer to the warranty included with the Kalia products for details.**

Product dimensions:

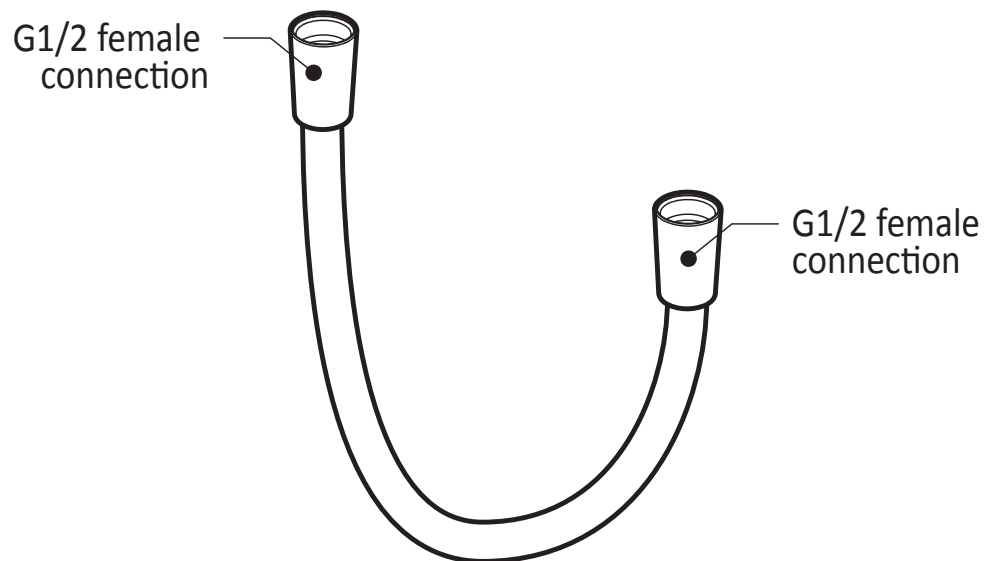

Important : Dimensions are approximated and are subject to changes. Please refer to the installation instructions.



Kalia

ONCE UPON A TIME...WATER®

1355, 2nd Street, Industrial Park
Sainte-Marie (Québec)
Canada G6E 1G9

T 418-387-9090
1-877-GO-KALIA (1-87-465-2542)
F 418 387-9089

KaliaStyle.com